

## SYSTEM DATASHEET

### Covering wall SO - 1x12,5 GKB A/CW 100/0,50 (W)

on a structure of CW 100 and UW 100 profiles made from sheet metal with a thickness of 0.5 mm with single-sheathing with GKB type A boards, thickness: 12.5 mm, with optional mineral wool filling

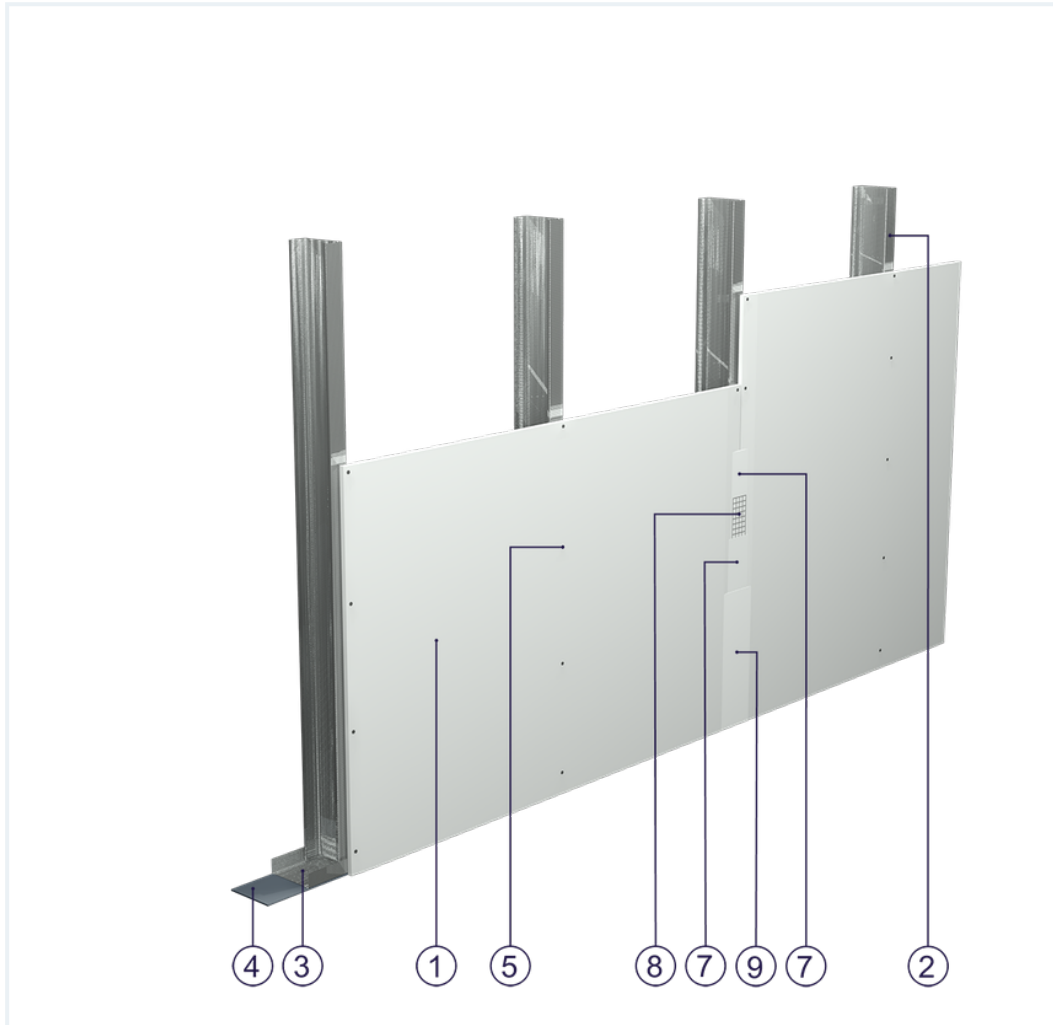



### Covering wall elements

1. Norgips S GKB type A plasterboards of 12.5 mm thickness 12.5 mm
2. Norgips CW 100 profiles (uprights) with 0.5 mm sheet thickness at max. 60 cm centre spacing
3. Norgips UW 100 profiles with 0.5 mm sheet thickness fixed to horizontal supporting elements
4. Norgips sealing tape, width 100 mm
5. Norgips 3.5 x 25 mm sheet metal screws, max. spacing every 25 cm
6. Fastening pins, min.  $\varnothing$  6 x 40 mm, max. spacing every 80 cm
7. Norgips Start & Finish ready-made joint compound or Norgips Start gypsum joint compound
8. Norgips reinforcing tape
9. Ready-made joint compound Norgips Extra Finish, ready-made joint compound Norgips Start & Finish, gypsum joint compound Norgips Finish
10. Optional mineral wool

## Technical data

 Max height  
4.0 m <sup>1)</sup>

 Wall mass  
9 kg/m<sup>2</sup> <sup>2)</sup>

 Acoustic insulation  
 $\Delta R_W$ =up to 12 dB <sup>3)</sup>

The above-mentioned parameters apply to a partition made of sheet metal profiles with a thickness of 0.5 mm.

- 1)** The stated heights apply to constructions with a profile spacing of 600 mm. When a structure with profiles spaced every 300 or 400 mm is used, the permissible wall height increases. Contact system provider representatives for details. The stated heights apply to rooms where only a few persons are present simultaneously (e.g. rooms in flats, hotels, hospitals). In rooms where a large number of persons are present simultaneously (e.g. conference rooms, classrooms, lecture halls), the permissible height is 3.4 m.
- 2)** The weight specified does not include the insulation material weight.
- 3)** Estimated increase in acoustic insulation effectiveness on the basis of the DIN 4109 standard

## Standard

 SMART

Provides a lightweight stable body with proven performance. The solution guarantees quality at an attractive price.

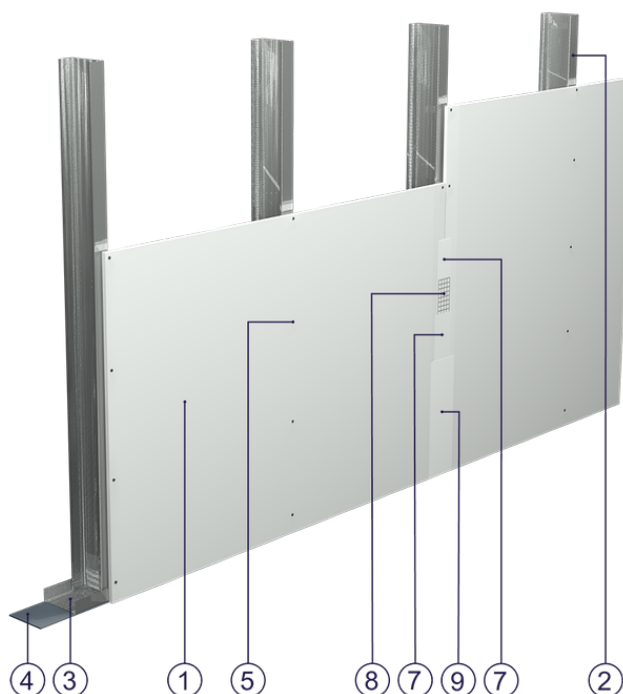

Fig. 1. Curtain wall view

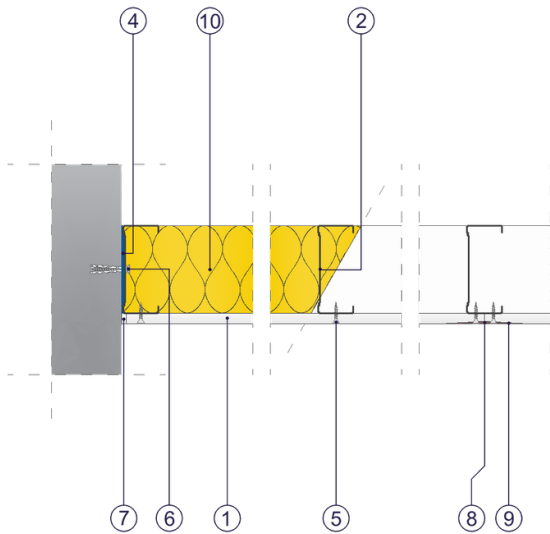

Fig. 2. Curtain wall horizontal section

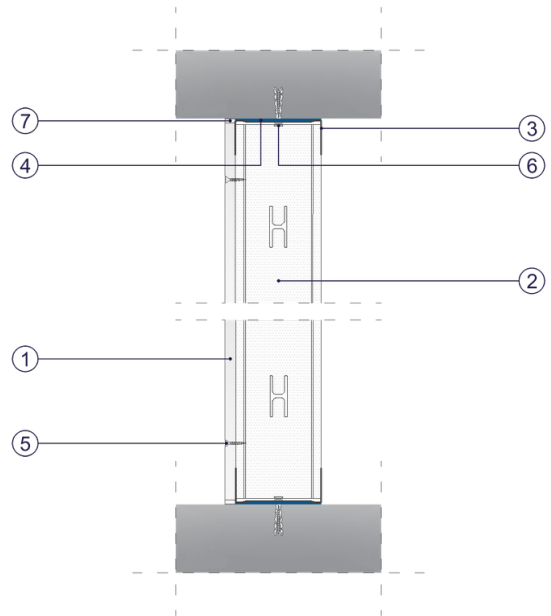

Fig. 3. Curtain wall vertical section