

SYSTEM DATASHEET

Suspended ceiling SPJ - 1x9,5 GKB A/CD 60, S

on a single-level grid made of CD 60 profiles mounted on rotary hangers with a spring, single sheathing with GKB type A boards, thickness: 9.5 mm



Suspended ceiling elements

1. Norgips S GKB type A plasterboards of 12.5 mm thickness 9.5 mm
2. Norgips CD 60 profiles for upper layer, axial spacing every 120 cm
3. Crosspiece made of Norgips CD 60 profiles, spacing every 40 cm
4. Profile Norgips UD 30
5. Optional Norgips sealing tape, width 30 mm
6. Norgips single sided lateral connectors
7. Norgips crosswise connectors
8. Norgips rotary hangers with springs, spacing every 70 cm
9. Norgips suspension rods
10. Norgips 3.5 x 25 mm sheet metal screws, max. spacing every 17 cm
11. Fastening pins, min. \varnothing 6 x 40 mm, max. spacing every 80 cm
12. Steel dowels, min. \varnothing 6 x 40 mm
13. Norgips Start & Finish ready-made joint compound or Norgips Start gypsum joint compound
14. Norgips reinforcing tape
15. Ready-made joint compound Norgips Extra Finish, ready-made joint compound Norgips Start & Finish, gypsum joint compound Norgips Finish

Technical data

	Lining weight 8 kg/m ² ¹⁾
--	--

The above-mentioned parameters apply to a partition made of sheet metal profiles with a thickness of 0.55 and 0.6 mm.

If a partition separates environments of various temperature levels, possible application of an insulating material must be preceded with an analysis of thermal and humidity conditions. Such an analysis may result, e.g. in the necessity to apply a vapour resistant foil.

1) The weight specified does not include the insulation material weight.

Standard

★ BASIC

Provides a lightweight stable building with basic fire resistance. A robust and cost-effective solution.



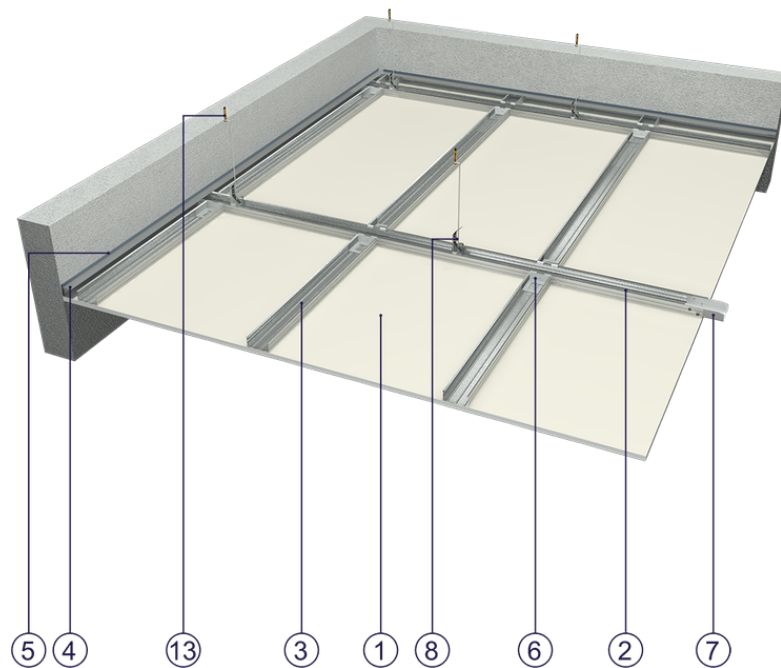

Fig. 1. Suspended ceiling view

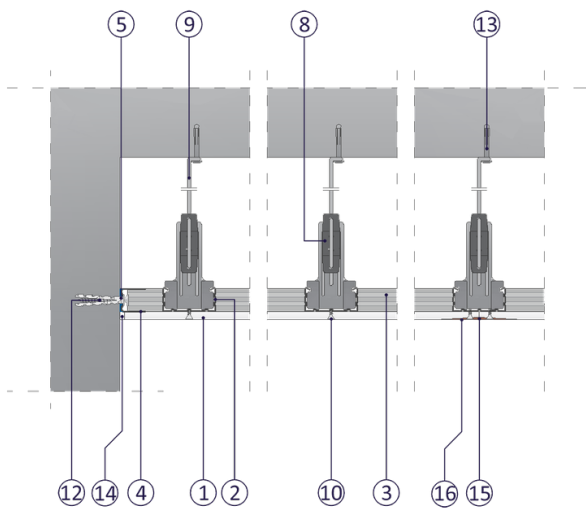

Fig. 2. Suspended ceiling horizontal section

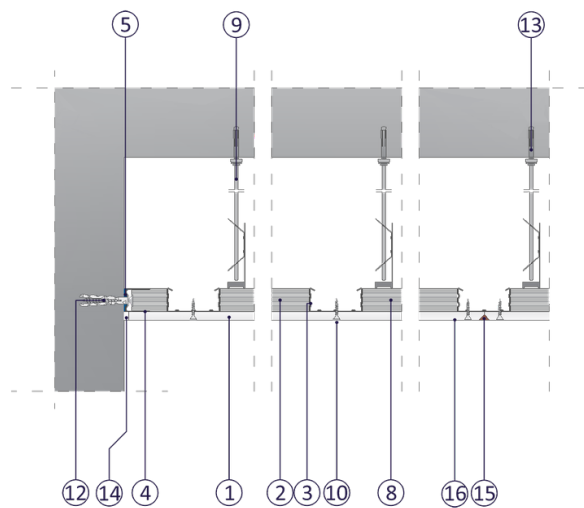

Fig. 3. Suspended ceiling vertical section