

SYSTEM DATASHEET

Covering wall SO - 1x15+2x12,5 GKFI DFH2/CW 100 (W)

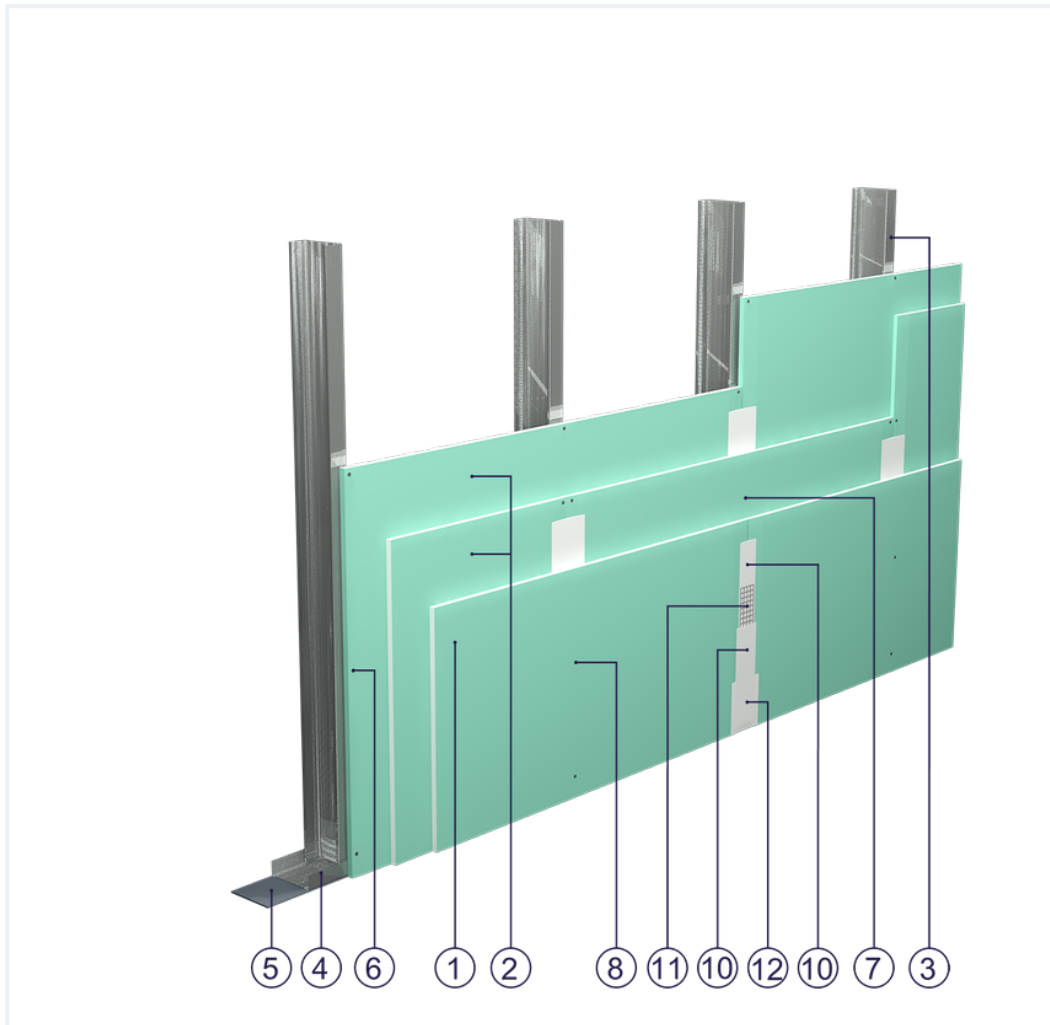



on a CW 100 and UW 100 profile structure with triple DFH2 type GKFI plasterboard boards. 1 x 15 + 2 x 12.5 mm, with optional mineral wool filling



Covering wall elements

1. Norgips S GKFI type DFH2 gypsum plasterboard , thickness: 15 mm
2. Norgips S GKFI type DFH2 gypsum plasterboard , thickness: 12.5 mm
3. Norgips CW 100 profiles, max. axial spacing every 60 cm
4. Norgips UW 100 profiles mounted on horizontal load-bearing elements
5. Norgips sealing tape, width 100 mm
6. Norgips 3.5 x 25 mm sheet metal screws, max. spacing every 75 cm
7. Norgips 3.5 x 45 mm sheet metal screws, max. spacing every 75 cm
8. Norgips 3.5 x 55 mm sheet metal screws, max. spacing every 25 cm
9. Fastening pins, min. \varnothing 6 x 40 mm, max. spacing every 80 cm
10. Norgips Start & Finish ready-made joint compound or Norgips Start gypsum joint compound
11. Norgips reinforcing tape
12. Ready-made joint compound Norgips Extra Finish, ready-made joint compound Norgips Start & Finish, gypsum joint compound Norgips Finish
13. Optional mineral wool

Technical data

 Fire resistance class EI 90 ($h_{\max}=4.6$ m) ^{1) 2)}	 Max height 4.6 m ¹⁾
 Wall mass 37 kg/m ² ³⁾	 Acoustic insulation ΔR_w =up to 12 dB ⁴⁾

The above-mentioned parameters apply to a partition made of sheet metal profiles with a thickness of 0.55 and 0.6 mm.

- 1) The stated heights apply to constructions with a profile spacing of 600 mm. When a structure with profiles spaced every 300 or 400 mm is used, the permissible wall height increases. Contact system provider representatives for details. The stated heights apply to rooms where only a few persons are present simultaneously (e.g. rooms in flats, hotels, hospitals). In rooms where a large number of persons are present simultaneously (e.g. conference rooms, classrooms, lecture halls), the permissible height is 3.9 m.
- 2) Based on classification no. LBO-767-K/21
- 3) The weight specified does not include the insulation material weight.
- 4) Estimated increase in acoustic insulation effectiveness on the basis of the DIN 4109 standard

Standard

★ ★ ★ SUPER

It provides a very stable building with the highest fire resistance, sound insulation and hardness. Increased moisture resistance.



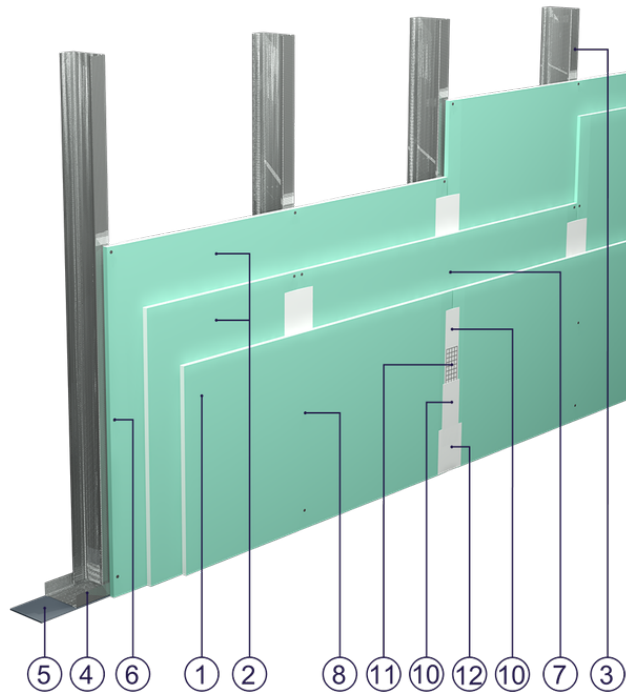

Fig. 1. Curtain wall view

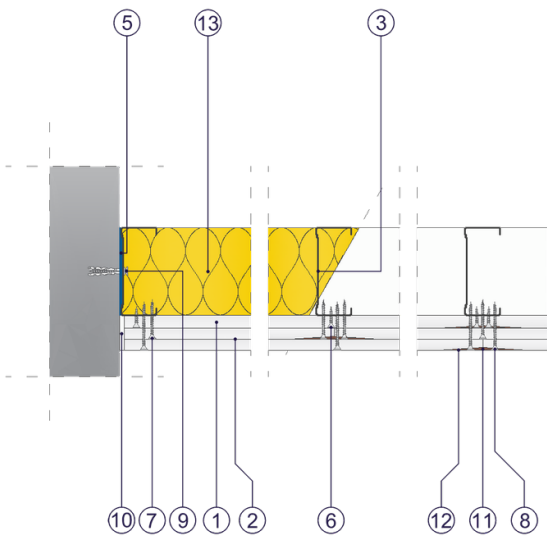

Fig. 2. Curtain wall horizontal section

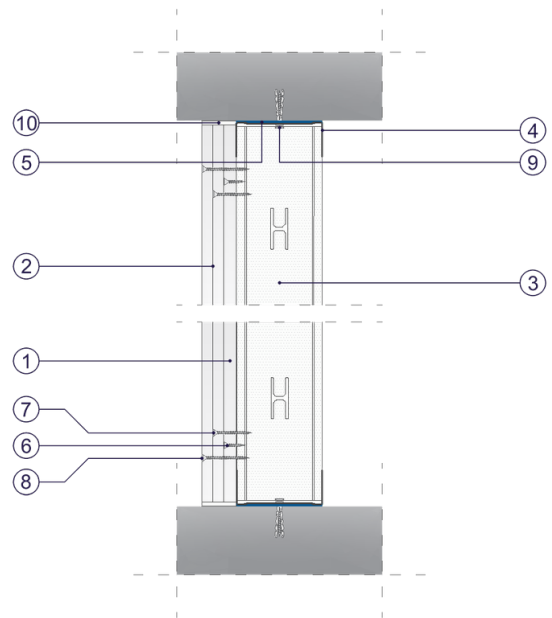

Fig. 3. Curtain wall vertical section