

## SYSTEM DATASHEET

### Covering wall SO - 2x15 GKF DF/CW 75 (W)

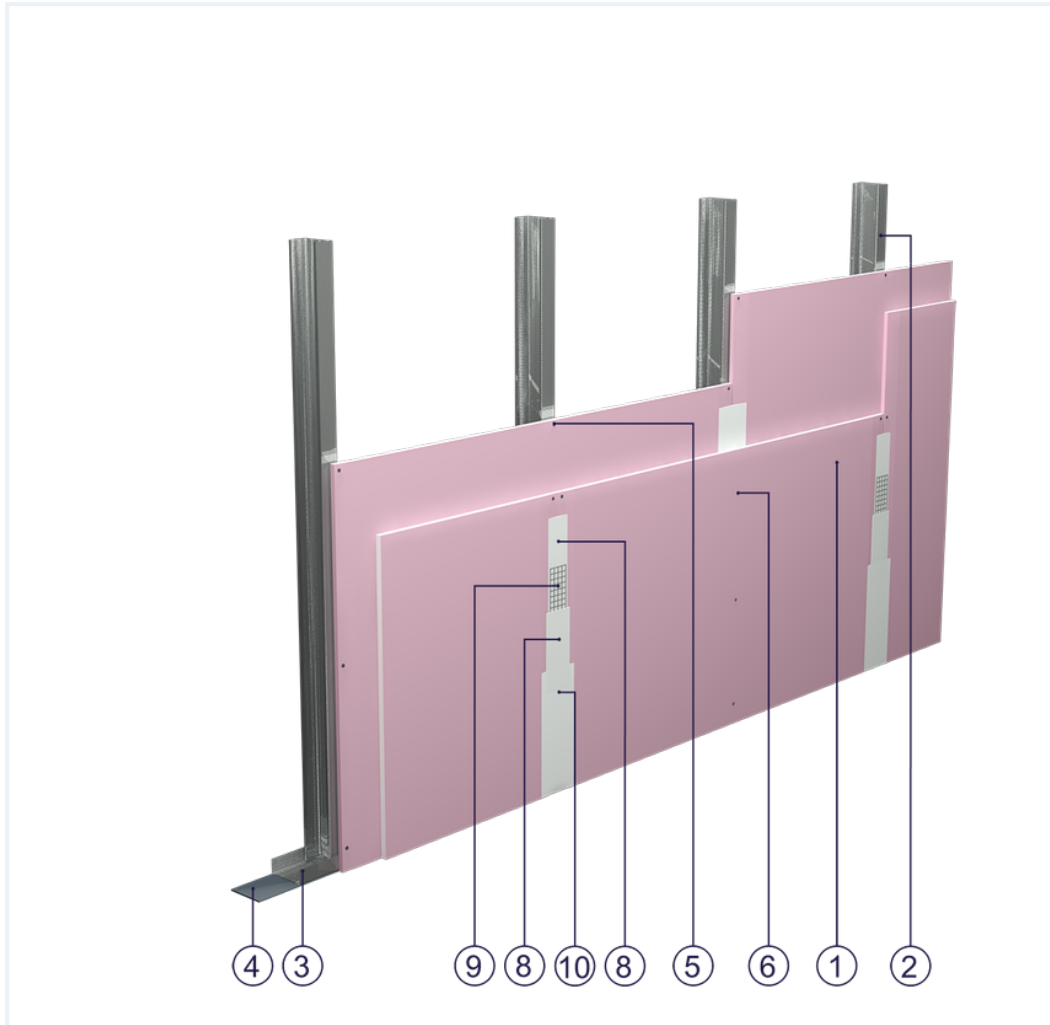



on a CW 75 and UW 75 profile structure with double, DF-type plasterboard sheathing with a thickness of 15 mm, with optional mineral wool filling



### Covering wall elements

1. Norgips S GKF type DF gypsum plasterboard , thickness: 15 mm
2. Norgips CW 75 profiles, max. axial spacing every 60 cm
3. Norgips UW 75 profiles mounted on horizontal load-bearing elements
4. Norgips sealing tape, width 75 mm
5. Norgips 3.5 x 25 mm sheet metal screws, max. spacing every 75 cm
6. Norgips 3.5 x 45 mm sheet metal screws, max. spacing every 25 cm
7. Fastening pins, min.  $\varnothing$  6 x 40 mm, max. spacing every 80 cm
8. Norgips Start & Finish ready-made joint compound or Norgips Start gypsum joint compound
9. Norgips reinforcing tape
10. Ready-made joint compound Norgips Extra Finish, ready-made joint compound Norgips Start & Finish, gypsum joint compound Norgips Finish
11. Optional mineral wool

## Technical data

	Fire resistance class EI 60 ( $h_{\max}=4.0$ m) <sup>1) 2)</sup>		Max height 4.0 m <sup>1)</sup>
	Wall mass 30 kg/m <sup>2</sup> <sup>3)</sup>		Acoustic insulation $\Delta R_w$ =up to 12 dB <sup>4)</sup>

The above-mentioned parameters apply to a partition made of sheet metal profiles with a thickness of 0.55 and 0.6 mm.

- 1)** The stated heights apply to constructions with a profile spacing of 600 mm. When a structure with profiles spaced every 300 or 400 mm is used, the permissible wall height increases. Contact system provider representatives for details. The stated heights apply to rooms where only a few persons are present simultaneously (e.g. rooms in flats, hotels, hospitals). In rooms where a large number of persons are present simultaneously (e.g. conference rooms, classrooms, lecture halls), the permissible height is 3.4 m.
- 2)** Based on classification no. LBO-057-K/20
- 3)** The weight specified does not include the insulation material weight.
- 4)** Estimated increase in acoustic insulation effectiveness on the basis of the DIN 4109 standard

## Standard

☆☆☆ SUPER

It provides a very stable building with the highest fire resistance, sound insulation and hardness.



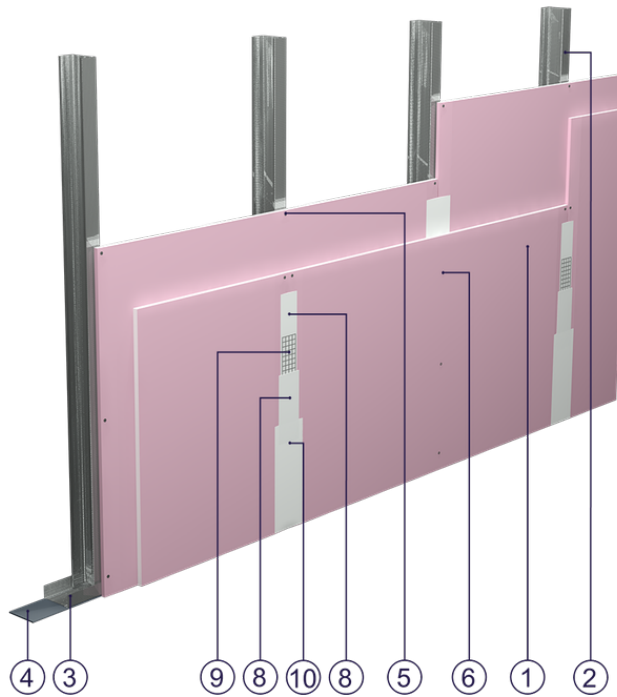

Fig. 1. Curtain wall view

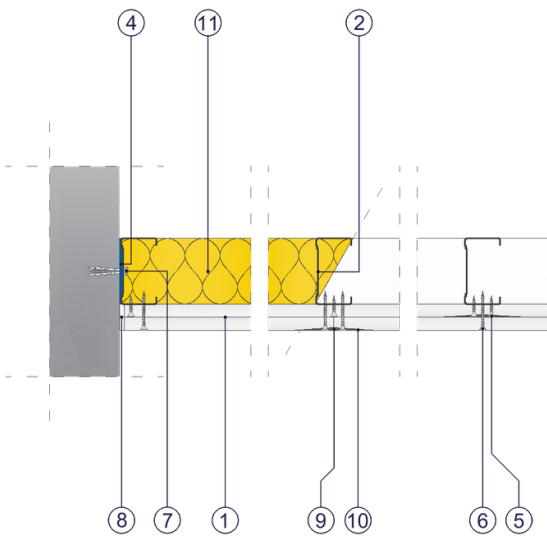

Fig. 2. Curtain wall horizontal section

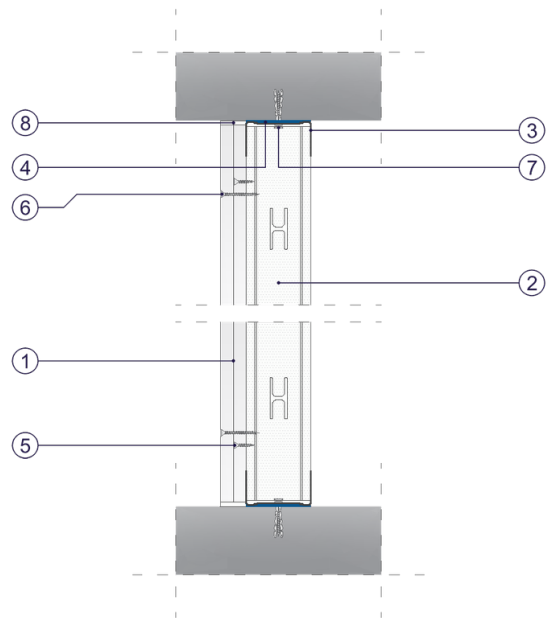

Fig. 3. Curtain wall vertical section