

SYSTEM DATASHEET

Covering wall SO - 1x15 GKF DF/CW 100 (W)

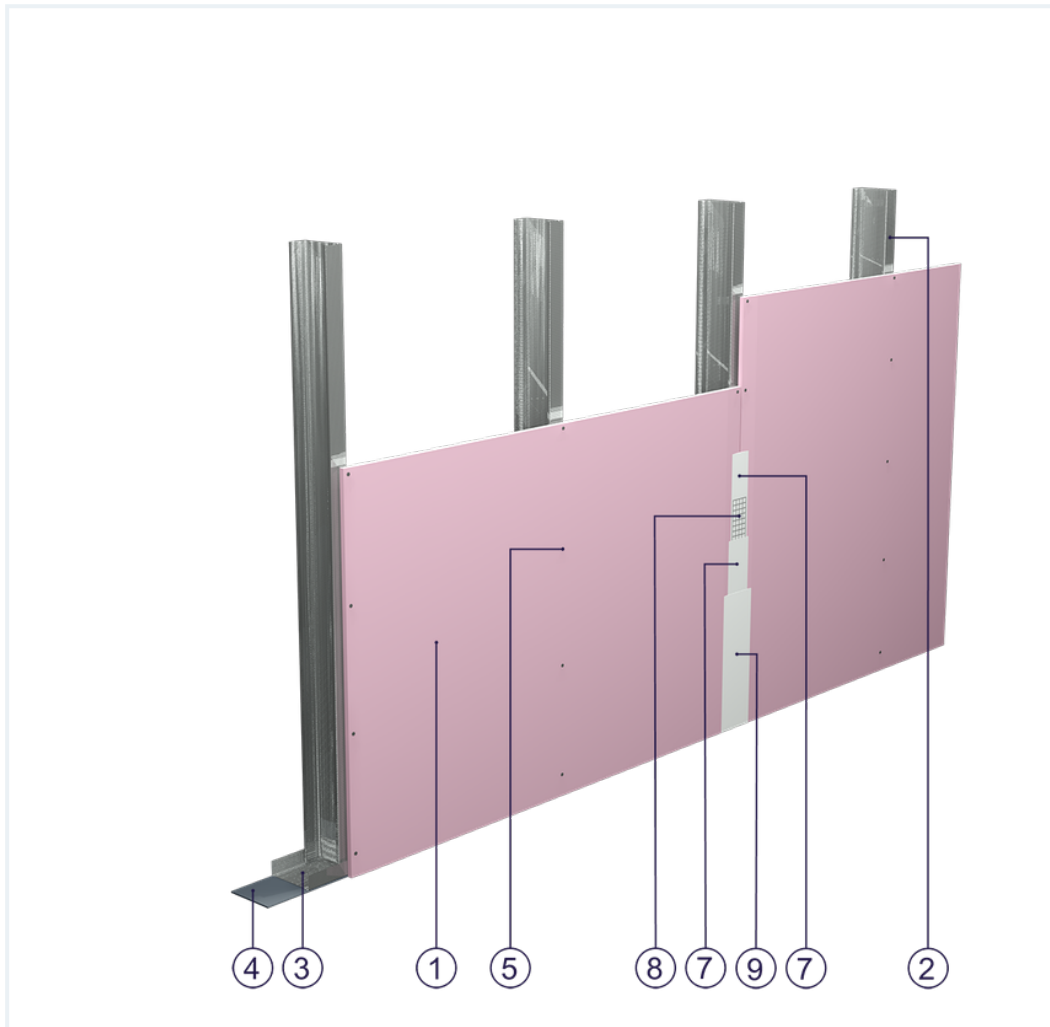



on a CW 100 and UW 100 profile structure with a single sheathing of DF type GKF boards with a thickness of 15 mm, with optional mineral wool filling



Covering wall elements

1. Norgips S GKF type DF gypsum plasterboard , thickness: 15 mm
2. Norgips CW 100 profiles, max. axial spacing every 60 cm
3. Norgips UW 100 profiles mounted on horizontal load-bearing elements
4. Norgips sealing tape, width 100 mm
5. Norgips 3.5 x 25 mm sheet metal screws, max. spacing every 25 cm
6. Fastening pins, min. Ø 6 x 40 mm, max. spacing every 80 cm
7. Norgips Start & Finish ready-made joint compound or Norgips Start gypsum joint compound
8. Norgips reinforcing tape
9. Ready-made joint compound Norgips Extra Finish, ready-made joint compound Norgips Start & Finish, gypsum joint compound Norgips Finish
10. Optional mineral wool

Technical data

 Fire resistance class EI 15	 Max height 4.1 m ¹⁾
 Wall mass 17 kg/m ² ²⁾	 Acoustic insulation $\Delta R_W = \text{up to } 12 \text{ dB}$ ³⁾

The above-mentioned parameters apply to a partition made of sheet metal profiles with a thickness of 0.55 and 0.6 mm.

- 1)** The stated heights apply to constructions with a profile spacing of 600 mm. When a structure with profiles spaced every 300 or 400 mm is used, the permissible wall height increases. Contact system provider representatives for details. The stated heights apply to rooms where only a few persons are present simultaneously (e.g. rooms in flats, hotels, hospitals). In rooms where a large number of persons are present simultaneously (e.g. conference rooms, classrooms, lecture halls), the permissible height is 3.4 m.
- 2)** The weight specified does not include the insulation material weight.
- 3)** Estimated increase in acoustic insulation effectiveness on the basis of the DIN 4109 standard

Standard

★ BASIC

Provides a lightweight stable building with basic fire resistance. A robust and cost-effective solution.

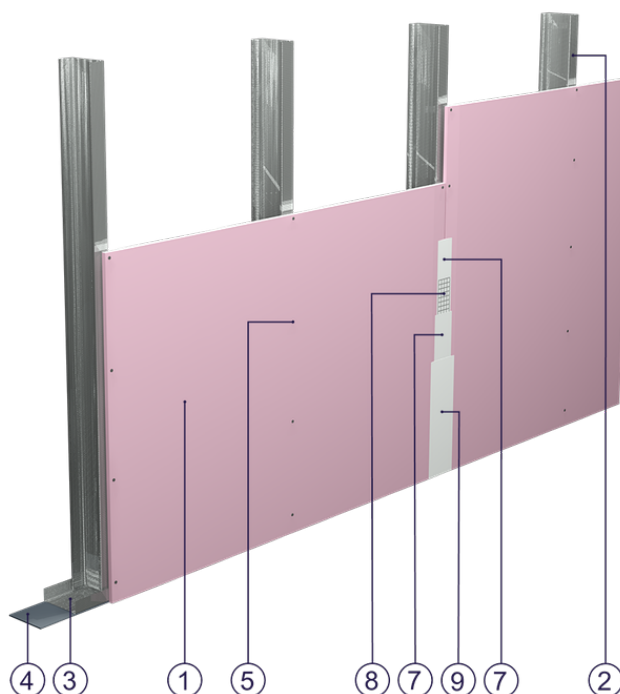

Fig. 1. Curtain wall view

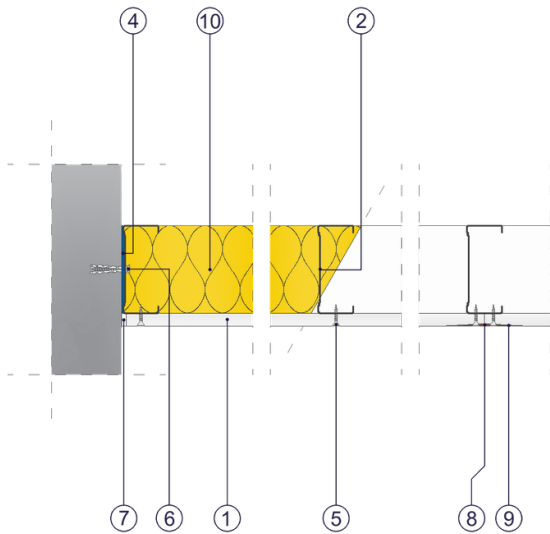

Fig. 2. Curtain wall horizontal section

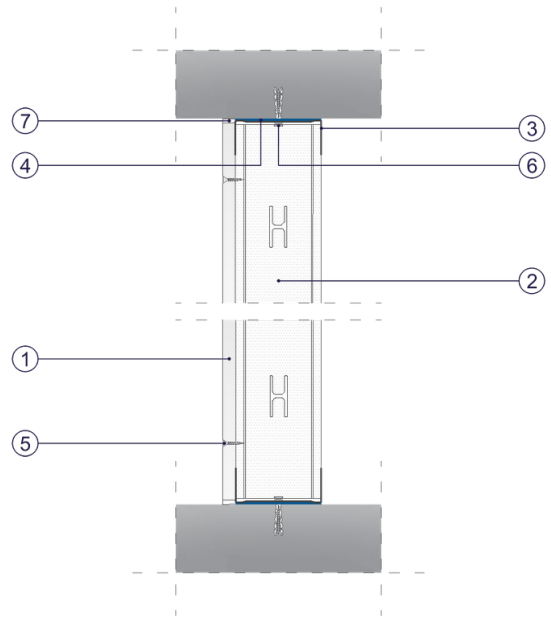

Fig. 3. Curtain wall vertical section