

SYSTEM DATASHEET

Covering wall SO - 1x12,5 GKB A/CW50 (W)

on a CW 50 and UW 50 profile structure with single plasterboard sheathing, type A, , thickness: 12.5 mm, with optional mineral wool filling

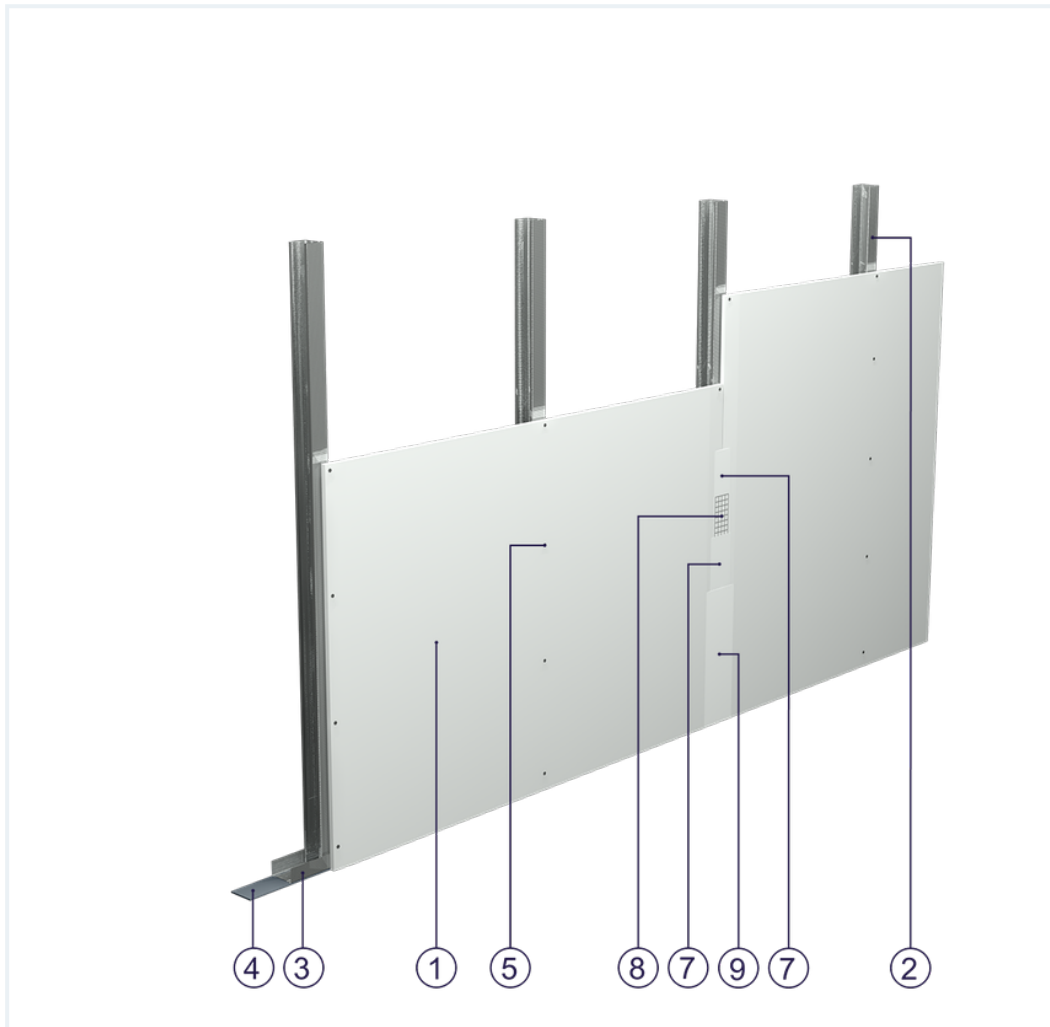



Covering wall elements

1. Norgips S GKB type A plasterboards of 12.5 mm thickness 12.5 mm
2. Norgips CW 50 profiles, max. axial spacing every 60 cm
3. Norgips UW 50 profiles mounted on horizontal load-bearing elements
4. Norgips sealing tape, width 50 mm
5. Norgips 3.5 x 25 mm sheet metal screws, max. spacing every 25 cm
6. Fastening pins, min. \varnothing 6 x 40 mm, max. spacing every 80 cm
7. Norgips Start & Finish ready-made joint compound or Norgips Start gypsum joint compound
8. Norgips reinforcing tape
9. Ready-made joint compound Norgips Extra Finish, ready-made joint compound Norgips Start & Finish, gypsum joint compound Norgips Finish
10. Optional mineral wool

Technical data

 Max height
2.3 m ¹⁾

 Wall mass
9 kg/m² ²⁾

 Acoustic insulation
 ΔR_W =up to 12 dB ³⁾

The above-mentioned parameters apply to a partition made of sheet metal profiles with a thickness of 0.55 and 0.6 mm.

- 1) The stated heights apply to constructions with a profile spacing of 600 mm. When a structure with profiles spaced every 300 or 400 mm is used, the permissible wall height increases. Contact system provider representatives for details. The stated heights apply to rooms where only a few persons are present simultaneously (e.g. rooms in flats, hotels, hospitals). In rooms where a large number of persons are present simultaneously (e.g. conference rooms, classrooms, lecture halls), the permissible height is 2.0 m.
- 2) The weight specified does not include the insulation material weight.
- 3) Estimated increase in acoustic insulation effectiveness on the basis of the DIN 4109 standard

Standard

★ BASIC

Provides a lightweight stable building with basic fire resistance. A robust and cost-effective solution.

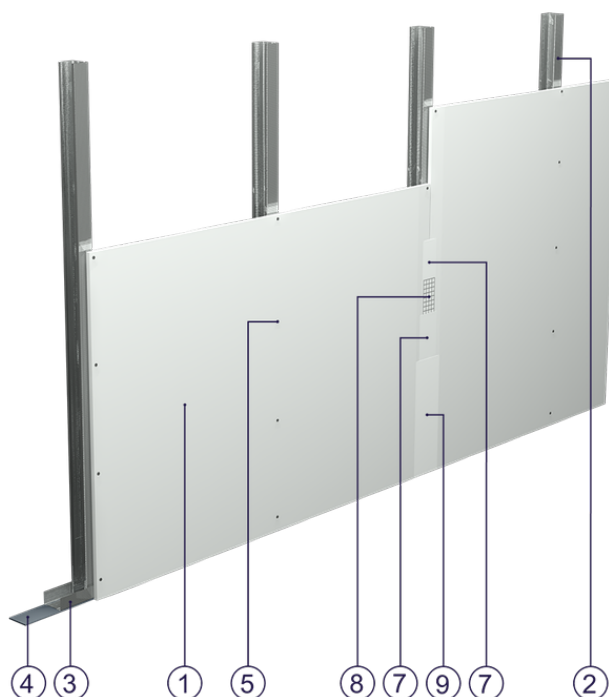

Fig. 1. Curtain wall view

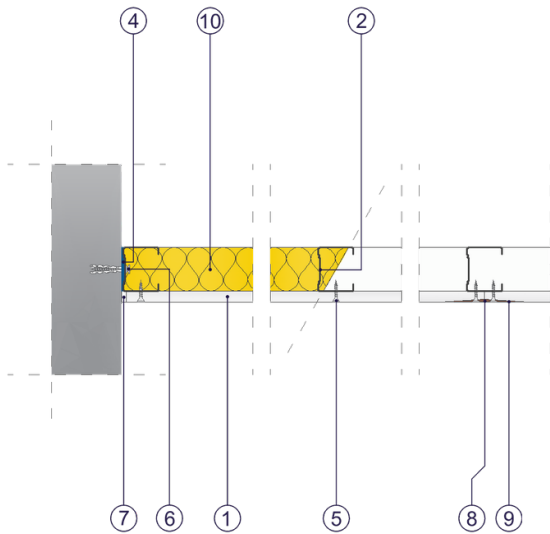

Fig. 2. Curtain wall horizontal section

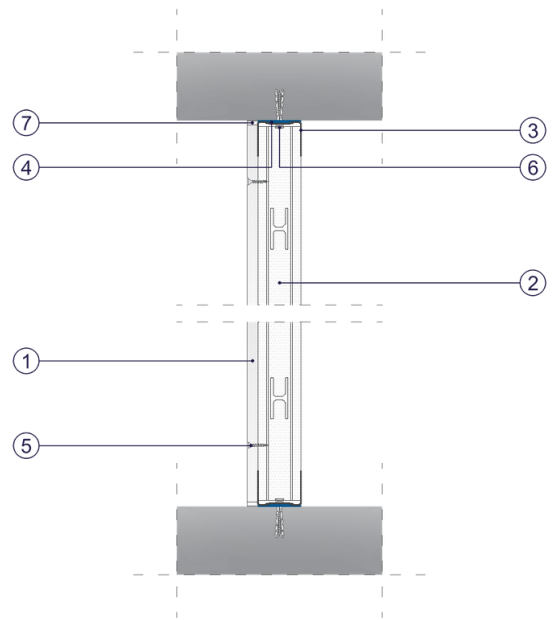

Fig. 3. Curtain wall vertical section