

SYSTEM DATASHEET

Partition wall SDI - 2x12,5 DFH2IRE/2xCW 75 W

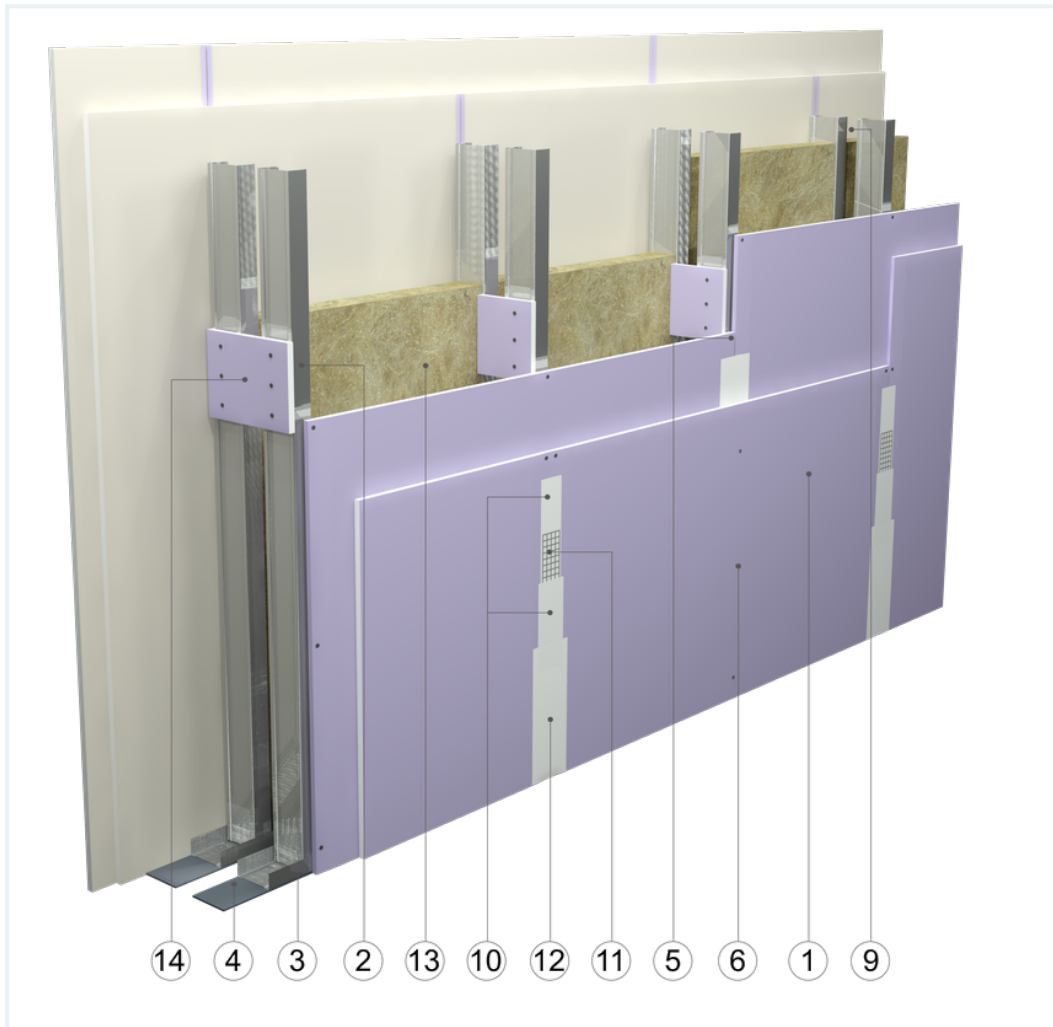



on a double structure of CW 75 and UW 75 profiles with double DFH2IR boards with a thickness of 12.5 mm with mineral wool filling



Partition wall components

1. Norgips S plasterboard type DFH2IR , thickness: 12.5 mm
2. Norgips CW 75 profiles, max. axial spacing every 60 cm
3. Norgips UW 75 profiles mounted on horizontal load-bearing elements
4. Norgips sealing tape, width 75 mm
5. Norgips 3.5 x 25 mm sheet metal screws, max. spacing every 75 cm
6. Norgips 3.5 x 35 mm sheet metal screws, max. spacing every 25 cm
7. Fastening pins, min. \varnothing 6 x 40 mm, max. spacing every 80 cm
8. Openings in studs for installation wires
9. Space for routing installation wires
10. Norgips Start & Finish ready-made joint compound or Norgips Start gypsum joint compound
11. Norgips reinforcing tape
12. Ready-made joint compound Norgips Extra Finish, ready-made joint compound Norgips Start & Finish, gypsum joint compound Norgips Finish
13. Mineral wool
14. Plasterboards of min. height of 30 cm, mounted with six 3.5 x 25 mm sheet metal screws

Technical data

 Fire resistance class EI 120 ($h_{\max}=6.0$ m) ^{1) 2)}	 Max height 6.5 m ¹⁾
 Wall mass 52 kg/m ² ³⁾	 Acoustic insulation $R_W=61$ dB ⁴⁾ $R_{A1}=59$ dB ⁴⁾

The above-mentioned parameters apply to a partition made of sheet metal profiles with a thickness of 0.55 and 0.6 mm.

- 1) The stated heights apply to constructions with a profile spacing of 600 mm. When a structure with profiles spaced every 300 or 400 mm is used, the permissible wall height increases. Contact system provider representatives for details. The stated heights apply to rooms where only a few persons are present simultaneously (e.g. rooms in flats, hotels, hospitals). In rooms where a large number of persons are present simultaneously (e.g. conference rooms, classrooms, lecture halls), the permissible height is 5.6 m.
- 2) Based on classification no. LBO-060-KZ/20
- 3) The weight specified does not include the insulation material weight.
- 4) Based on report no. LA03-06041/13/R14NA for 75 mm glass wool

Standard

☆☆☆ SUPER

It provides a very stable building with the highest fire resistance, sound insulation and hardness. Increased moisture resistance.



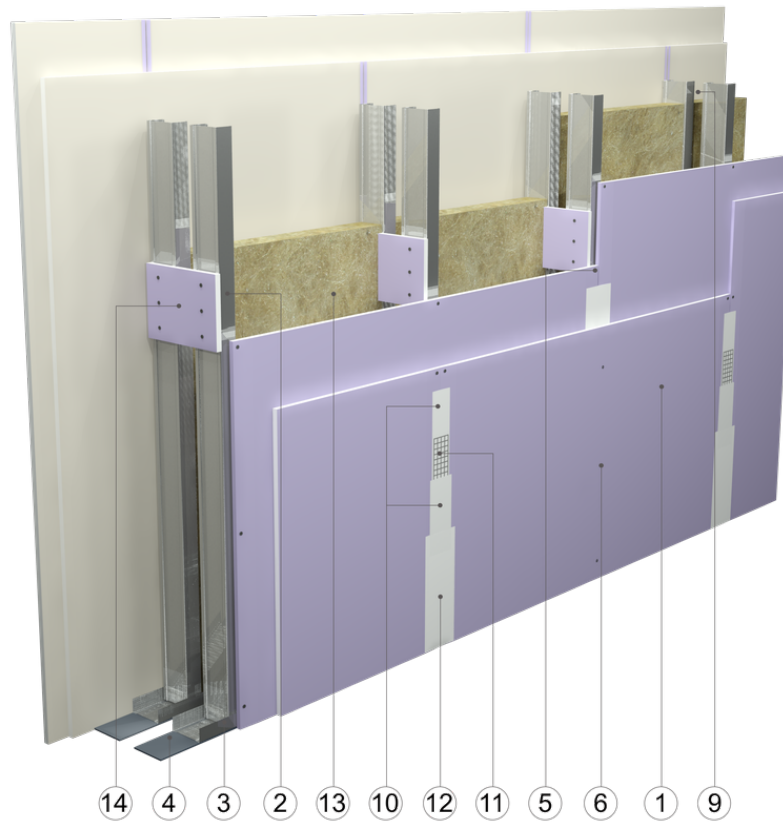

Fig. 1. Partition wall view

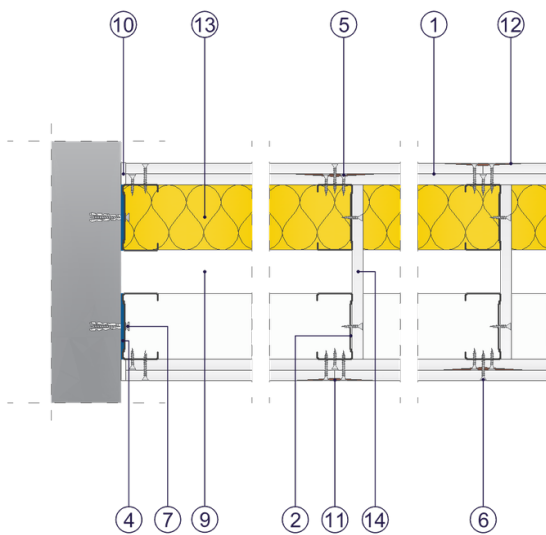

Fig. 2. Partition wall horizontal section

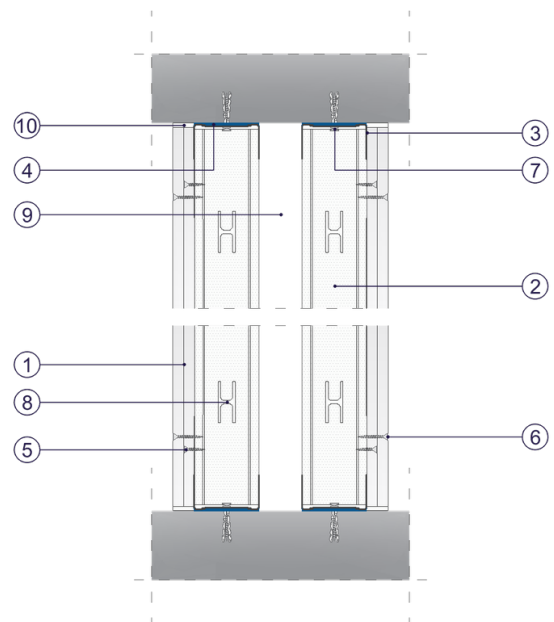

Fig. 3. Partition wall vertical section