

## SYSTEM DATASHEET

### Partition wall SDI - 2x12,5 GKF DF/2xCW 75 W

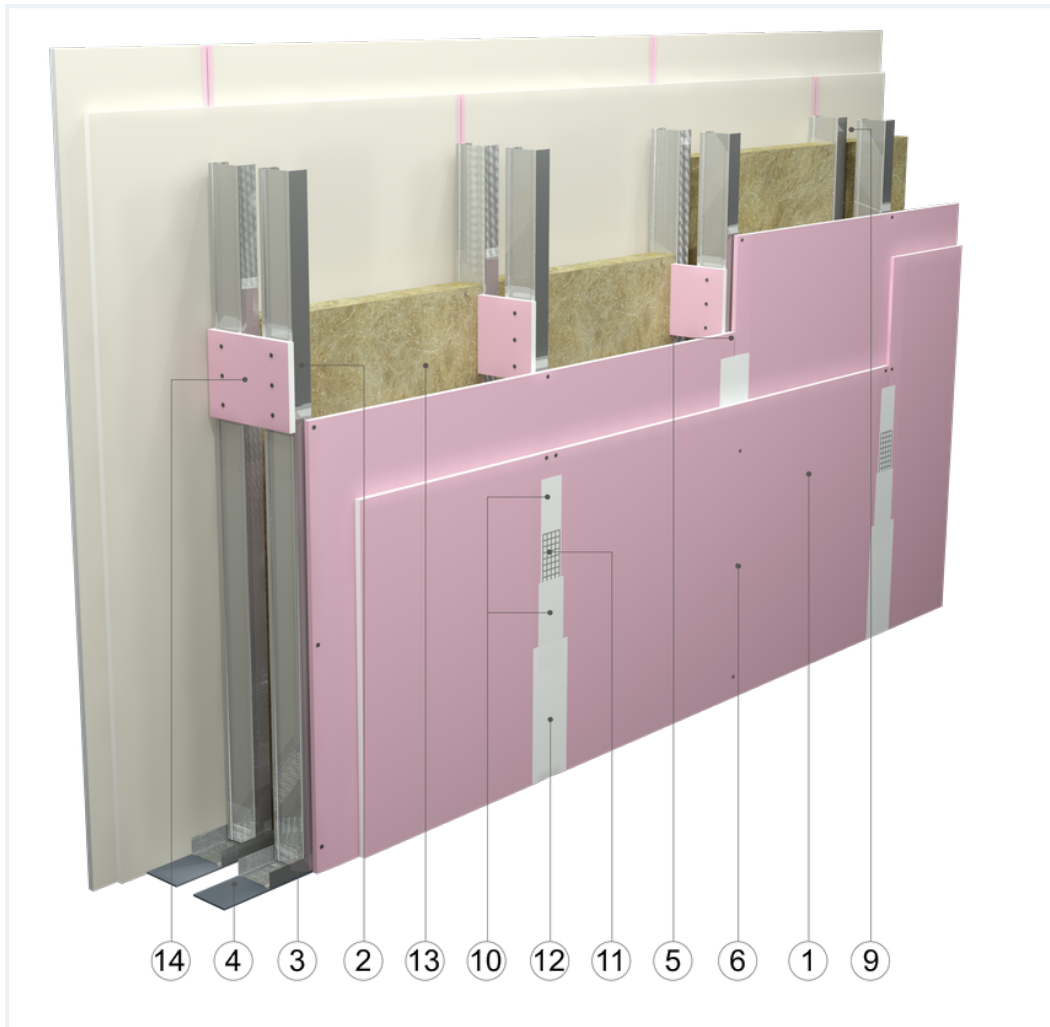



on a double structure of CW 75 and UW 75 profiles with double sheathing of DF type GKF boards with a thickness of 12.5 mm with mineral wool filling



## Partition wall components

1. Norgips S GKF type DF gypsum plasterboard , thickness: 12.5 mm
2. Norgips CW 75 profiles, max. axial spacing every 60 cm
3. Norgips UW 75 profiles mounted on horizontal load-bearing elements
4. Norgips sealing tape, width 75 mm
5. Norgips 3.5 x 25 mm sheet metal screws, max. spacing every 75 cm
6. Norgips 3.5 x 35 mm sheet metal screws, max. spacing every 25 cm
7. Fastening pins, min.  $\varnothing$  6 x 40 mm, max. spacing every 80 cm
8. Openings in studs for installation wires
9. Space for routing installation wires
10. Norgips Start & Finish ready-made joint compound or Norgips Start gypsum joint compound
11. Norgips reinforcing tape
12. Ready-made joint compound Norgips Extra Finish, ready-made joint compound Norgips Start & Finish, gypsum joint compound Norgips Finish
13. Mineral wool
14. Plasterboards of min. height of 30 cm, mounted with six 3.5 x 25 mm sheet metal screws

## Technical data

 Fire resistance class EI 120 ( $h_{\max}=6.0$ m) <sup>1) 2)</sup>	 Max height 6.5 m <sup>1)</sup>
 Wall mass 46 kg/m <sup>2</sup> <sup>3)</sup>	 Acoustic insulation $R_W=55$ dB $R_{A1}=51$ dB

The above-mentioned parameters apply to a partition made of sheet metal profiles with a thickness of 0.55 and 0.6 mm.

- 1) The stated heights apply to constructions with a profile spacing of 600 mm. When a structure with profiles spaced every 300 or 400 mm is used, the permissible wall height increases. Contact system provider representatives for details. The stated heights apply to rooms where only a few persons are present simultaneously (e.g. rooms in flats, hotels, hospitals). In rooms where a large number of persons are present simultaneously (e.g. conference rooms, classrooms, lecture halls), the permissible height is 5.6 m.
- 2) Based on classification no. LBO-060-KZ/20
- 3) The weight specified does not include the insulation material weight.

## Standard

★ ★ ★ SUPER

It provides a very stable building with the highest fire resistance, sound insulation and hardness.



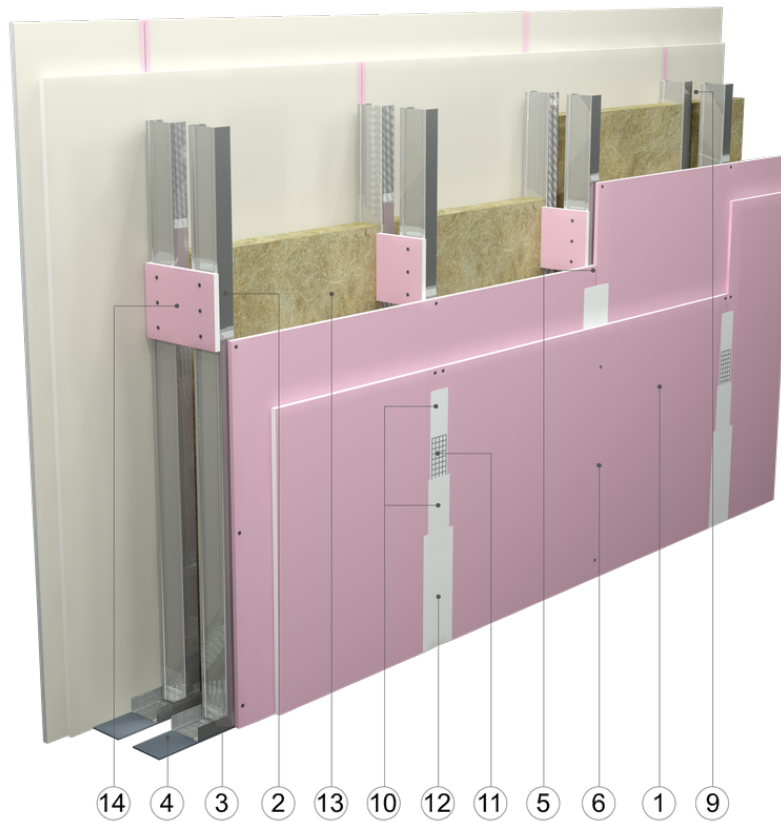

Fig. 1. Partition wall view

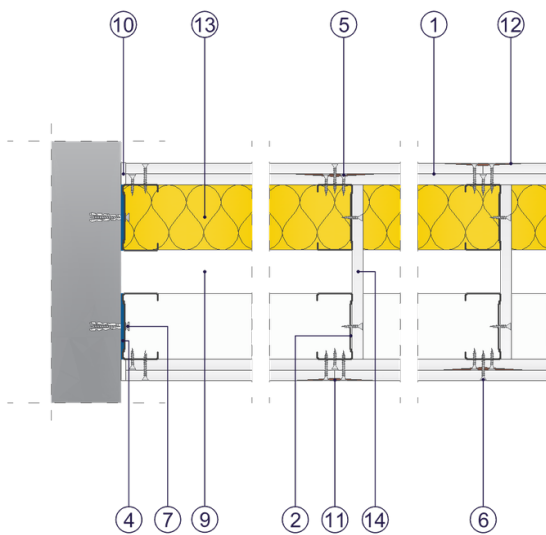

Fig. 2. Partition wall horizontal section

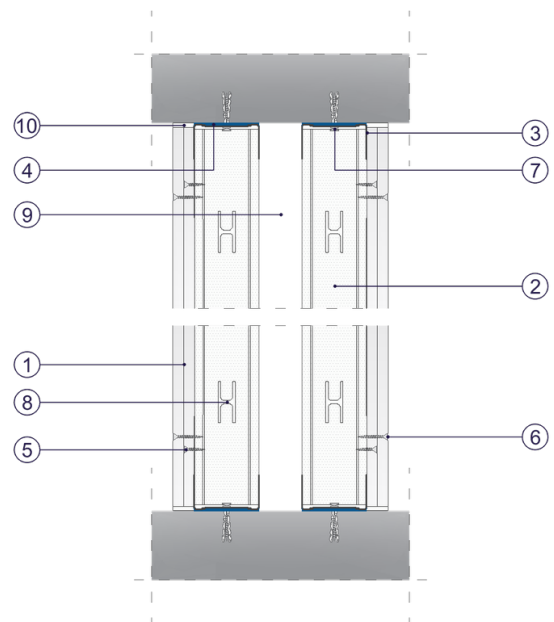

Fig. 3. Partition wall vertical section