

SYSTEM DATASHEET

Partition wall SD - 2x12,5 GKF DF/2xCW 50 2xW

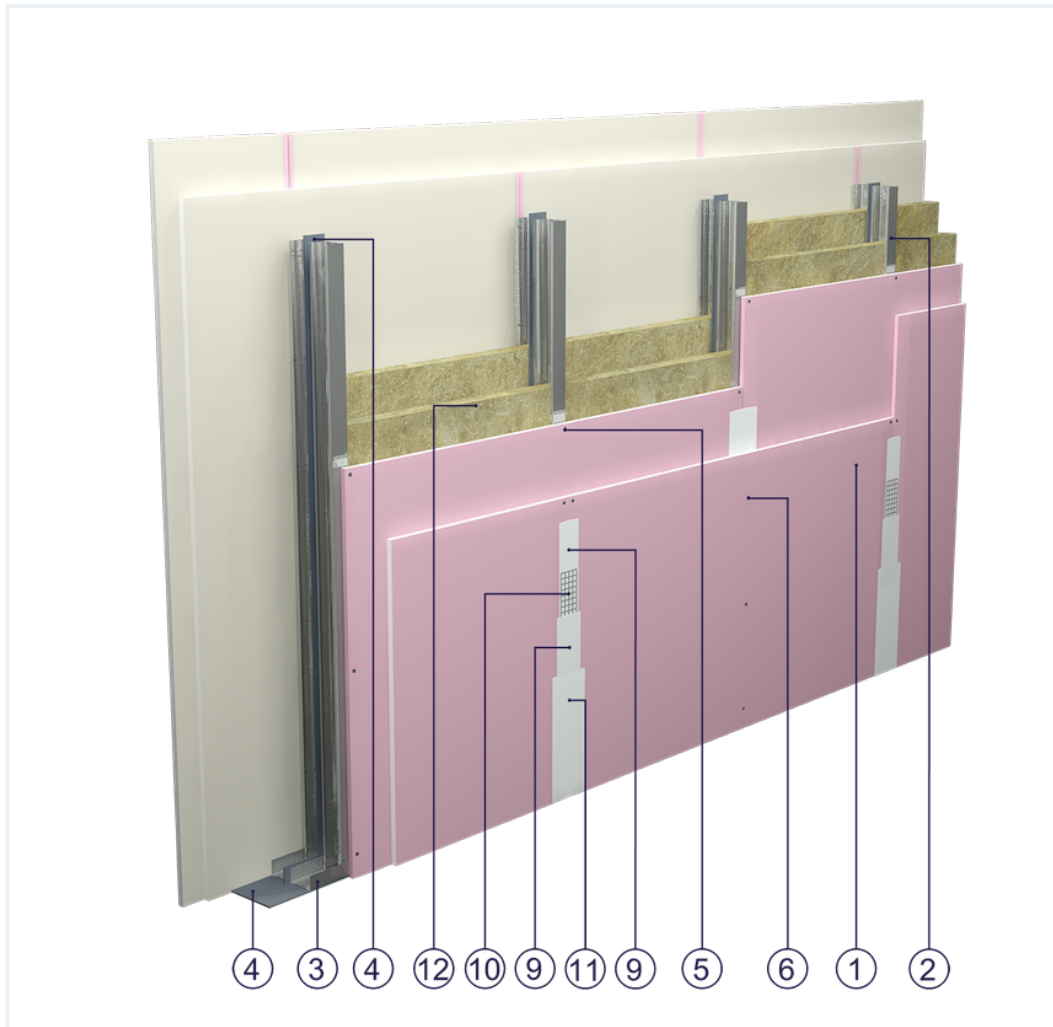



on a double structure of CW 50 and UW 50 profiles with double sheathing of DF type GKF boards with a thickness of 12.5 mm with mineral wool filling



Partition wall components

1. Norgips S GKF type DF gypsum plasterboard , thickness: 12.5 mm
2. Norgips CW 50 profiles, max. axial spacing every 60 cm
3. Norgips UW 50 profiles mounted on horizontal load-bearing elements
4. Norgips sealing tape, width 50 mm
5. Norgips 3.5 x 25 mm sheet metal screws, max. spacing every 75 cm
6. Norgips 3.5 x 35 mm sheet metal screws, max. spacing every 25 cm
7. Fastening pins, min. \varnothing 6 x 40 mm, max. spacing every 80 cm
8. Openings in studs for installation wires
9. Norgips Start & Finish ready-made joint compound or Norgips Start gypsum joint compound
10. Norgips reinforcing tape
11. Ready-made joint compound Norgips Extra Finish, ready-made joint compound Norgips Start & Finish, gypsum joint compound Norgips Finish
12. Mineral wool

Technical data

 Fire resistance class EI 120 ($h_{\max}=4.0$ m) ^{1) 2)}	 Max height 4.4 m ¹⁾
 Wall mass 44 kg/m ² ³⁾	 Acoustic insulation $R_W=62$ dB ⁴⁾ $R_{A1}=58$ dB ⁴⁾

The above-mentioned parameters apply to a partition made of sheet metal profiles with a thickness of 0.55 and 0.6 mm.

- 1) The stated heights apply to constructions with a profile spacing of 600 mm. When a structure with profiles spaced every 300 or 400 mm is used, the permissible wall height increases. Contact system provider representatives for details. The stated heights apply to rooms where only a few persons are present simultaneously (e.g. rooms in flats, hotels, hospitals). In rooms where a large number of persons are present simultaneously (e.g. conference rooms, classrooms, lecture halls), the permissible height is 3.7 m.
- 2) Based on classification no. LBO-060-KZ/20
- 3) The weight specified does not include the insulation material weight.
- 4) Based on report no. A 211002 for 2x50 mm glass wool

Standard

☆☆☆ SUPER

It provides a very stable building with the highest fire resistance, sound insulation and hardness.



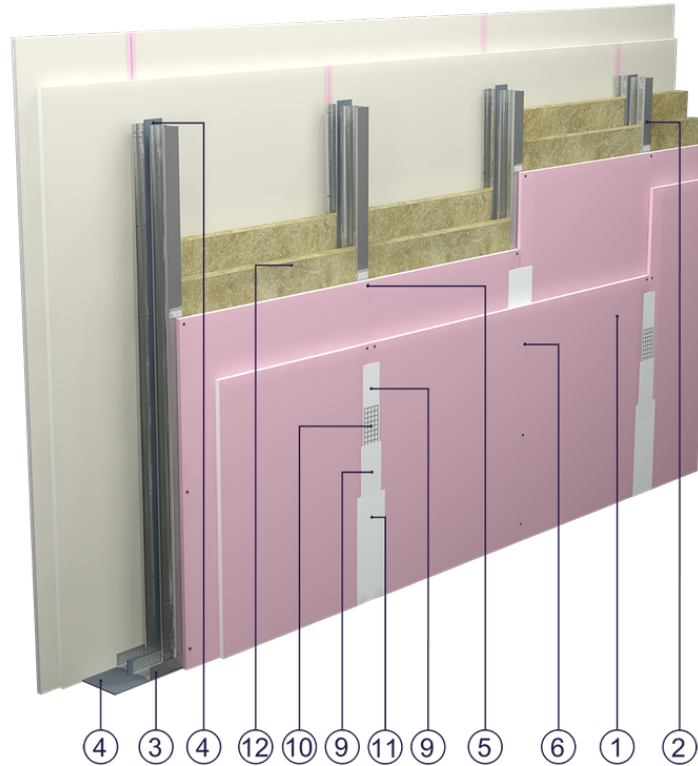

Fig. 1. Partition wall view

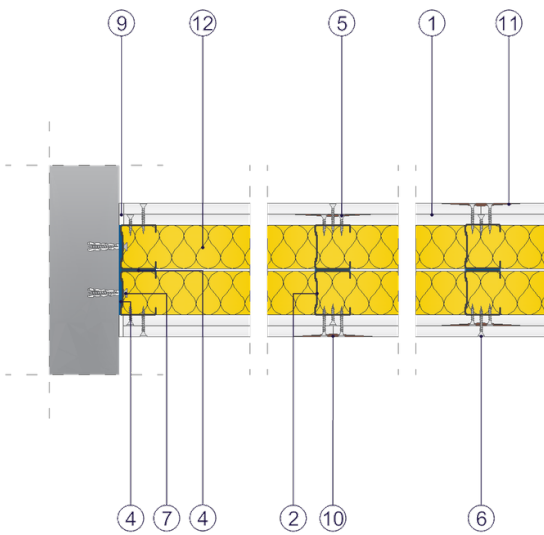

Fig. 2. Partition wall horizontal section

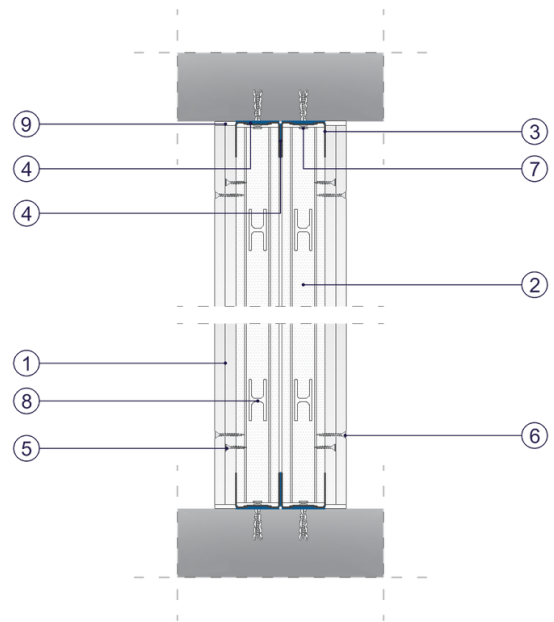

Fig. 3. Partition wall vertical section